

SHIPBOARD CRANE BLOCK 2 SHEAVES



Finish	:	Painted
Temperature Range	:	-20 °C up to +180 °C (-40 °C on request)
Standard Certification	:	Certificate of Conformity
Certification on Request	:	3.1 material Certificate EN 10204



Several options for painting according ISO 12944 on request.

Proof Load Certificate on request.

Non-standard sizes or custom products available on request.

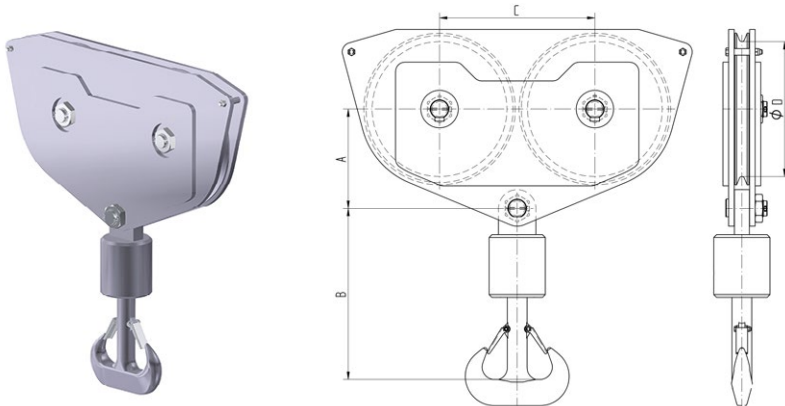

SWL	ØRope size	ØSheaves	Weight
tons	mm		kg ±
25	30	720/630	1000
32	32	720/630	1100
45	35	810/720	1400
50	38	810/720	1700
60	40	890/800	2000